

# MXB/MXG

## Motor driven 2, 3 port ball valve

■ For water, hot water, air, oil, corrosive fluids, steam

### Overview

Water hammering is eliminated with CKD original ball opening/closing structure.

This valve is suitable for water and hot water controls, and oil and steam applications. Even with its small size, the flow rate is large and the pressure loss is small.

The outstanding sealing properties and durability enable use in a variety of applications.

### Features

#### High quality seal

A back-up O ring ensures a high quality seal.

#### No burn damage in motor-locked state

Impedance and thermal protections ensure that the motor does not burn even if the ball locks.

\* Always observe the cycle rate.

#### Forward/reverse rotation operation

(except for the MH<sub>G</sub>4 Series)

#### No limits to pressurization direction

(except for 3-way valves)

#### Signal detection and manual override are provided.

#### Class IPX3 "rainproof" actuator protection

(For standard and options T and K only.  
Note that the MH<sub>G</sub>4 and MHBP Series are excluded.)

#### Motor driven proportional control ball valves are also available.

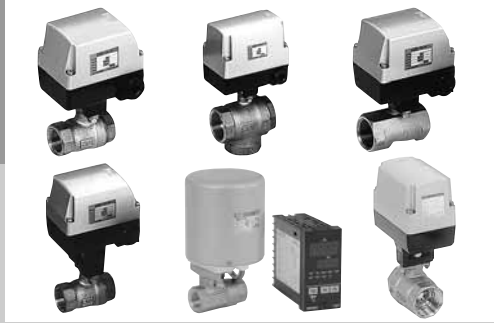

## CONTENTS

Series variation	552
⚠ Safety precautions	554
Wiring diagram	557
<b>Standard type</b>	
● 2 port valve	MXB1/MXB1F 558
● 3 port valve	MXG1 562
<b>High corrosion resistance</b>	
● 2 port valve	MXB1-C 566
<b>Oil-free specifications</b>	
● 2 port valve	MXB1-N/MXB1D-N 582
● 3 port valve	MXG1-N/MXG1D-N 586
<b>For steam</b>	
● 2 port valve	MSB1/MSB1F 590
<b>With relay</b>	
● 2 port valve	MXB1D/MXB1DF 570
● 3 port valve	MXG1D 574
<b>High corrosion resistance / with relay</b>	
● 2 port valve	MXB1D-C 578
<b>For steam / with relay</b>	
● 2 port valve	MSB1D/MSB1DF 594
<b>Proportional control</b>	
● 2 port valve	MXBC 598
● 3 port valve	MXGC 598
● Motor valve type temperature control system	MHBP 608
<b>Miniature type</b>	
● 2 port valve	MHB4 602
● 3 port valve	MHG4 602
Electronic Catalog file list	612

⚠ Always read the precautions in the Introduction and page 554 before starting use.

HNB/G

USB/G

FAB/G

FGB/G

FVB

FWB/G

FHB

FLB

AB

AG

AP/

AD

APK/

ADK

For

dry air

Explosion

proof

HVB/

HVL

SAB/

SVB

NP/NAP/

NVP

CHB/G

MXB/G

Other G.P.

systems

PD/FAD/

PJ

CVE/

CVSE

CPE/

CPD







Medical

analysis

Custom

order

Motor driven 2, 3 port ball valve

Applications/purposes	Model	Bore shape	
General control	Standard type 	MXB1	Standard bore
		MXB1F	Full bore
		MXG1	Standard bore
Compact type	Miniature type 	MHB3	Reduced bore
		MHG3	
		MHB4	
		MHG4	
Parallel operation with other valves is available Valve open/close at ON/OFF contact	With relay 	MXB1D	Standard bore
		MXB1DF	Full bore
		MXG1D	Standard bore
For pure water and cleaning	Oil-free specifications 	MXB1-N	Standard bore
		MXG1-N	
		MXB1D-N	
		MXG1D-N	
For steam and hot water	For steam 	MSB1	Standard bore
		MSB1F	Full bore
		MSB1D	Standard bore
		MSB1DF	Full bore
Accurate flow control	Proportional control type 	MXBC	Standard bore
		MXGC	
		MHBP	
Responding to service interruption	Self reset type	MHBR	Standard bore
Acid water/alkaline water control	For ionized water	MHG4-20X913	Reduced bore

	Fluid				Port size (Upper: Nominal, Lower: Port size)							Page
	Water, hot water	Air	Oil	Steam	10A	15A	20A	25A	32A	40A	50A	
					3/8	1/2	3/4	1	1 1/4	1 1/2	2	
●	●	●		● <sub>*1</sub>	●	●	●	●	●	●	●	558
●	●	●			●	●	●	●	●	●		558
●	●	●				●	●	●	●	●	●	562
●	●			●	●							636
●	●			●	●							636
●	●	●		●	●	●						602
●	●	●		●	●	●						602
●	●	●		● <sub>*1</sub>	●	●	●	●	●	●	●	570
●	●	●			●	●	●	●	●	●		570
●	●	●				●	●	●	●	●	●	574
●	●			●	●	●	●	●	●	●	●	582
●	●					●	●	●	●	●	●	586
●	●			●	●	●	●	●	●	●	●	582
●	●					●	●	●	●	●	●	586
●			●	● <sub>*1</sub>	●	●	●	●	●	●	●	590
●			●			●	●	●	●	●		590
●			●	● <sub>*1</sub>	●	●	●	●	●	●	●	594
●			●			●	●	●	●	●		594
●				● <sub>*1</sub>	●	●	●					598
●						●	●	●				598
●			●			●	●	●				608
●						●	●	●				636
●						●						823

\*1: The model belongs to the standard bore type, but it has a full bore structure.

\*2: For details on differences by bore shape, refer to the orifice diameter and dimensions on each page.

HNB/G  
 USB/G  
 FAB/G  
 FGB/G  
 FVB  
 FWB/G  
 FHB  
 FLB  
 AB  
 AG  
 AP/  
 AD  
 APK/  
 ADK  
 For  
 dry air  
 Explosion  
 proof  
 HVB/  
 HVL  
 SAB/  
 SVB  
 NP/NAP/  
 NVP  
 CHB/G  
 MXB/G  
 Other G.P.  
 systems  
 PD/FAD/  
 PJ  
 CVE/  
 CVSE  
 CPE/  
 CPD  
 Medical  
 analysis  
 Custom  
 order  
 Motor driven 2, 3 port ball valve



## Safety precautions

Always read this section before starting use.

### Motor driven ball valve (MXB1/MXB1F/MXG1/MXB1D/MXB1DF/MXG1D/MSB1/MSB1F/MSB1D/MSB1DF/MHB4/MHG4/MHBP)

#### Design & Selection

#### CAUTION

##### 1 Fluid viscosity

Generally, the valve can be used with a fluid viscosity of up to 500 mm<sup>2</sup>/s. However, the properties may differ according to the fluid type, so consult with CKD.

##### 2 Fluid properties

Iron rust and dirt, etc., in the fluid can cause operation faults or leaks and reduce product performance.

#### Installation, Piping & Wiring

#### CAUTION

##### 1 Installation

- (1) Always hold the body when handling or installing the product. Do not pull the lead wires or drop the product.
- (2) Install the valve within the range between vertical position with actuator facing upward and horizontal position.
- (3) Avoid outdoor installation.

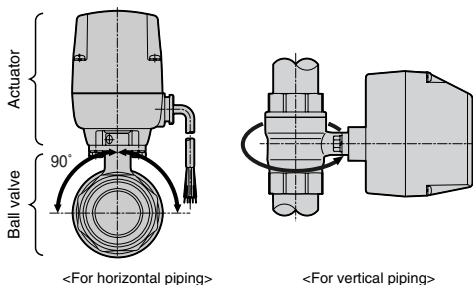

##### 2 Piping

- (1) Fix the product when tightening or reinstalling the piping. When piping to the body side, fix the body, and when piping to the cap side, fix the cap.
- (2) Fix and support the pipes so that the weight and vibration of the pipes are not directly applied on the valves.
- (3) The pressurization direction, limited for the 3-way valve, must be observed.
- (4) When using heat insulating material, do not cover the actuator.

##### 3 Wiring

- (1) Connection is shown in the wiring diagram in page 557 or is attached to the bonnet. Follow the wiring diagram.
- (2) When using the DC specifications, use a capacitance power supply.  
An all wave or half wave rectified bridge is affected by ripples, so always use a stabilized power supply.
- (3) Avoid using a changeover switch with red and black lead wires as the signals could be input simultaneously.
- (4) Parallel operation of motor driven ball valves (excluding MXB1D/MXB1DF/MXG1D/MSB1D/MSB1DF)  
Do not operate more than one ball valve in parallel using the same contact. Otherwise, operation faults will occur.

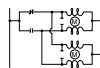

In parallel operation, insert a separate contact for each ball valve.

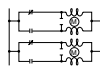

- (5) Parallel operation with other valves, etc. (excluding MXB1D/MXB1DF/MXG1D/MSB1D/MSB1DF)  
Do not operate in parallel with other products having different resistance, such as a solenoid valve or contact protection element, using the same contact. Otherwise, operation faults will occur.

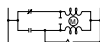

In parallel operation, insert a contact between the ball valve and solenoid valve, etc.

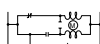

- (6) When not using the signal detection wire, cut the exposed core of the yellow and green wires, and insulate the wire ends.
- (7) When using the signal detection wire with a large capacity load or extremely small load, etc., use within the specifications of the micro switch.

Model no.	Maker name, type
MXB1/MXB1F/MXG1/MXB1D/MXB1DF/MXG1D/MSB1/MSB1F/MSB1D/MSB1DF	OMRON SS-5
MHB4/MHG4	Matsushita Electric Works AH1680
MHBP	OMRON SS-5GL

- (8) When using in a place where water splashes on the valve, take measures to protect the lead wire connection section.
- (9) When wiring a terminal box with indicator light, do not remove the cover with force.  
Otherwise, the crimp terminals inside could bend, and indicator lighting faults or insulation faults could occur.

HNB/G  
 USB/G  
 FAB/G  
 FGB/G  
 FVB  
 FWB/G  
 FHB  
 FLB  
 AB  
 AG  
 AP/  
 AD  
 APK/  
 ADK  
 For  
 dry air  
 Explosion  
 proof  
 HVB/  
 HVL  
 SAB/  
 SVB  
 NP/NAP/  
 NVP  
 CHB/G  
 MXB/G  
 Other G.P.  
 systems  
 PD/FAD/  
 PJ  
 CVE/  
 CVSE  
 CPE/  
 CPD  
 Medical  
 analysis  
 Custom  
 order

## When Using

### **WARNING**

#### **1** Cycle rate

Always observe the cycle rate. Otherwise, the thermal protector could operate and stop the valve. In the locked state, a continuously energized state could be created placing a load on the gears and coils. Turn the power off immediately, and eliminate the problem. Continuing use could result in operation faults or reduce the durability.

### **CAUTION**

#### **1** Signal switchover

Switch the valve signal so that the next signal is input after the valve operation ends. If operation is stopped or if the signal is switched midway, operation faults could occur and the service life could be shortened.

#### **2** Manual operation

This applies to the MXB1, MXB1F, MXB1D, MXB1DF, MSB1, MSB1F, MSB1D and MSB1DF. For the large bore sizes (standard bore: Rc1 1/4 to Rc2, full bore: Rc1 to Rc1 1/2), this applies to valves with manual override "M".

##### **<Manual operation method>**

- For the small bore sizes (standard bore: Rc3/8 to Rc1, full bore: Rc1/2 to Rc3/4), insert a cross-recessed screwdriver, etc., in the open/close indication hole on the intermediate bush of the motor valve, and slowly rotate it.
- For the large bore sizes (standard bore: Rc1 1/4 to Rc2, full bore: Rc1 to Rc1 1/2) with manual override "M", insert a cross-recessed screwdriver, etc., under the connection key at the intermediate bush, and slowly rotate it with the clutch disengaged.
- Rotate for about 20 seconds between the closed and open positions and vice versa.
- For both the large and small bore sizes, rotating in the counterclockwise direction looking at the valve from above will lead to "opening", and rotating in the clockwise direction will lead to "closing".

##### **<Precautions for manual operation>**

- Always turn the power OFF before starting.
- Do not apply sudden force when rotating the screwdriver as the gears could be damaged.
- For the large bore sizes (standard bore: Rc1 1/4 to Rc2, full bore: Rc1 to Rc1 1/2) with manual override "M", always return the clutch after manual operation, and make sure that the clutch is accurately connected before starting operation.
- Manual operations must be performed only in emergencies.

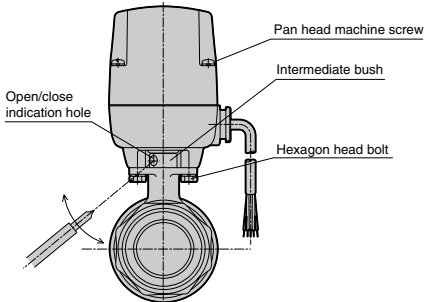

## Maintenance

### **WARNING**

#### **1** Never remove the bonnet.

Touching the electric parts inside could lead to electric shocks.

#### **2** Do not disassemble the product.

If a fault occurs, do not disassemble the product. Contact your nearest dealer or CKD Sales Office. Investigation of the cause is no longer possible if the product is disassembled.

Motor driven 2, 3 port ball valve



## Safety precautions

Always read this section before starting use.

### Motor driven proportional control ball valve (MXBC/MXGC)

#### Design & Selection

#### CAUTION

##### 1 Power supply

Select the power supply allowing for a sufficient capacity (50 W class is recommended). Do not use a full wave rectified bridge as it is affected by ripples or zero voltage, etc. Instead, use a stabilized power supply.

##### 2 Control methods

Use a controller or thermostat having a PID function, and keep the energizing frequency at 10% or less. When using for ON/OFF control or control with a high energizing frequency, the service life will be shortened, and the thermal protector could be activated due to motor heating. This will temporarily shut off the motor power and prevent correct operations. Lowering the energizing frequency will allow the service life of the entire device to be lengthened, so carefully consider the control methods and energizing frequency.

##### 3 Service life

The product's service life will differ greatly according to the operation. However, as a guide, the life is approx. 12 to 18 months when used with an energizing frequency of 10% for eight hours a day.

##### 4 Input signal and Cv flow factor

The ball valve opening degree position and input signal are initially adjusted as follow.

Input signal	Ball valve open/close position
0 mA	Fully closed position
20 mA	Fully opened position

As shown below, the Cv flow factor variation in one step will increase in the areas where the Cv flow factor is small or near the maximum flow rate. Thus, avoid using in these ranges, and obtain stability by controlling so that the expression maximum Cv flow factor x 1/2 = required flow rate is satisfied.

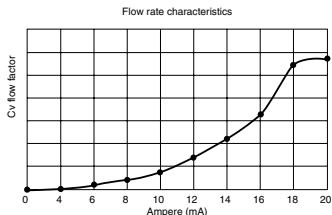

The angle at which the ball valve starts to open and the Cv flow factor in respect to the input signal will differ according to the product.

##### 5 Noise

When using outdoor piping, use resin piping to prevent damage from lightning. A stepping motor is used, so noise will be generated at the power line. Thus, use noise filters on devices susceptible to noise, such as computers connected to the common power supply.

##### 6 Actual control

- (1) Temperature control: When controlling the heating or cooling temperature, attention must be paid to the balance of the applied and lost heat. If the heat is not balanced, the control will not stabilize, and vibration could occur causing a large error. Design the device with balance in mind, considering the required fluid flow rate and temperature in respect to the target temperature.
- (2) Constant flow rate control: The resolution of the ball valve is 2.5% or less. Thus, it may not be possible to attain the required flow rate if more precise resolution is required. When using at high pressures, note that this resolution limit is particularly apparent.

##### 7 Fluid viscosity

Generally, the valve can be used with a fluid viscosity of up to 500 mm<sup>2</sup>/s. However, the properties may differ according to the fluid type, so consult with CKD.

<<Miscellaneous>> Refer to page 554 for the precautions regarding the motor driven ball valve.

### Installation, Piping & Wiring

#### WARNING

##### 1 Wiring

Refer to page 557.

<<Miscellaneous>> Refer to page 554 for the precautions regarding the motor driven ball valve.

### When Using

#### WARNING

<<Miscellaneous>> Refer to page 555 for the precautions regarding the motor driven ball valve.

### Maintenance

#### WARNING

<<Miscellaneous>> Refer to page 555 for the precautions regarding the motor driven ball valve.

## MX<sub>2</sub> 1/MXB1F/MSB1/MSB1F wiring diagram

### ● Standard type

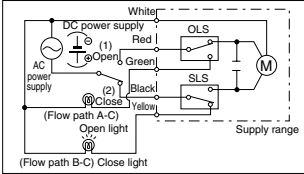

### ● Option: T (3-conductor cable)

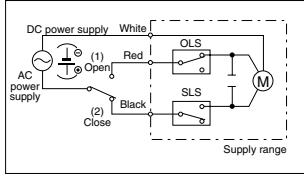

### ● Option: L, R (with indicator light)

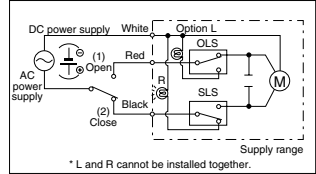

### 2 port valve

Opening operation (1): White - red After opening, the micro switch (OLS) functions and stops the motor.

Closing operation (2): White - black After closing, the micro switch (SLS) functions and stops the motor.

### 3 port valve

Flow path A-C (1): White - red After flow path A-C operates, the micro switch (OLS) functions and stops the motor.

Flow path B-C (2): White - black After flow path B-C operates, the micro switch (SLS) functions and stops the motor.

## MX<sub>2</sub> 1D/MXB1DF/MSB1D/MSB1DF (with relay) wiring diagram

### ● Standard type

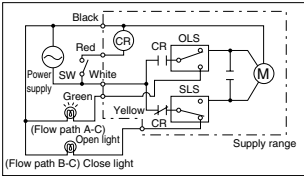

### ● Option: T (3-conductor cable)

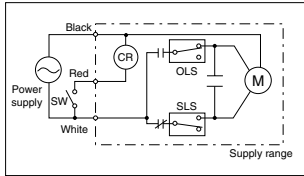

### ● Option: L, R (with indicator light)

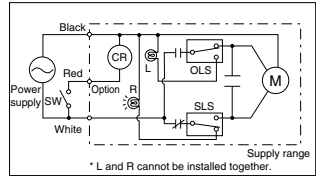

### 2 port valve

Opening operation SW: ON (black - white, red) After opening, the micro switch (OLS) functions and stops the motor.

Closing operation SW: OFF (black - white) After closing, the micro switch (SLS) functions and stops the motor.

### 3 port valve

Flow path A-C SW: ON (black - white, red) After flow path A-C operates, the micro switch (OLS) functions and stops the motor.

Flow path B-C SW: OFF (black - white) After flow path B-C operates, the micro switch (SLS) functions and stops the motor.

## MX<sub>2</sub> C (motor driven proportional control ball valve) wiring diagram

### ● MX<sub>2</sub> C (standard type)

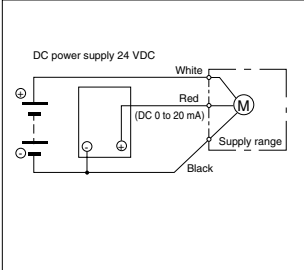

### 2 port valve

Opening operation 20 mA

Closing operation 0 (4) mA

### 3 port valve

Flow path A-C 20 mA

Flow path B-C 0 (4) mA

### ● MX<sub>2</sub> C-N (simple control type)

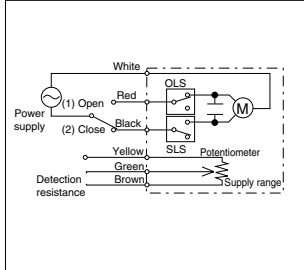

### 2 port valve

Opening operation (1): Brown - green Detection resistance 2.4 to 3.2 kΩ

Closing operation (2): Brown - green Detection resistance 0.1 to 0.9 kΩ

### 3 port valve

Flow path A-C (1): Brown - green Detection resistance 2.4 to 3.2 kΩ

Flow path B-C (2): Brown - green Detection resistance 0.1 to 0.9 kΩ

## MH<sub>2</sub> 4 wiring diagram

### ● MH<sub>2</sub> 4

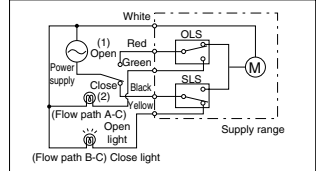

### 2 port valve

Opening operation (1): White - red

Closing operation (2): White - black

### 3 port valve

Flow path A-C (1): White - red

Flow path B-C (2): White - black

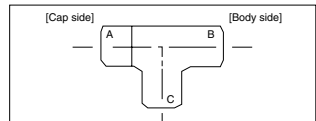

HNB/G

USB/G

FAB/G

FGB/G

FVB

FWB/G

FHB

FLB

AB

AG

AP/  
AD

APK/  
ADK

For  
dry air

Explosion  
proof

HVB/  
HVL

SAB/  
SVB

NP/NAP/  
NVP

CHB/G

MXB/G

Other G.P.  
systems

PD/FAD/  
PJ

CVE/  
CVSE

CPE/  
CPD

Medical  
analysis

Custom  
order

Motor driven 2, 3 port ball valve



# MXB1/MXB1F Series

- Port size: Rc3/8 to Rc2



## JIS symbol

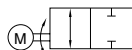

## Common specifications

Item	MXB1 (standard bore)/MXB1F (full bore)						
Working fluid	Water, hot water, air, oil (500 mm <sup>2</sup> /s or less)						
Working pressure range MPa	0 to 1.0 (refer to working pressure range in individual specifications. )						
Withstanding pressure (water) MPa	2.0						
Fluid temperature °C	0 to 80 (no freezing)						
Ambient temperature °C	-10 to 50						
Ambient humidity	95 or less						
Valve seat leakage cm <sup>3</sup> /min.	0 (at water pressure 1.0 MPa or 0.5 MPa (only for port size Rc2))						
Mounting attitude	Limited to vertical position with actuator facing upward to horizontal position.						
Pressurization direction	Random						
Protection grade	IPX3 "rainproof type" (standard and option T only)						
Electric specifications	MXB1-10	MXB1-15	MXB1-20	MXB1-25	MXB1-32	MXB1-40	MXB1-50
	MXB1F-15		MXB1F-20		MXB1F-25	MXB1F-32	MXB1F-40
Rated voltage	Note 1 100 VAC (50/60 Hz), 200 VAC (50/60 Hz), 12 VDC, 24 VDC						
Apparent power VA	100 VAC	4.9/5.9 (50/60 Hz)			13/15 (50/60 Hz)		
		5.4/6.2 (50/60 Hz)			13/15 (50/60 Hz)		
	200 VAC	4.9/5.9 (50/60 Hz)			13/15 (50/60 Hz)		
		5.4/6.2 (50/60 Hz)			13/15 (50/60 Hz)		
Average ampere	12 VDC	1.1			1.5		
	A Note 2 24 VDC	0.7			1.0		
Peak ampere	12 VDC	1.8 or less			3 or less		
	A Note 2 24 VDC	1.2 or less			2 or less		
Power consumption w	AC	7			15		
	12 VDC	13			18		
	24 VDC	17			24		

## MXB1 (standard bore) individual specifications

Item	MXB1-10 <sup>Note 3</sup>	MXB1-15	MXB1-20	MXB1-25	MXB1-32	MXB1-40	MXB1-50	
Port size	Rc3/8	Rc1/2	Rc3/4	Rc1	Rc1 1/4	Rc1 1/2	Rc2	
Orifice mm	10	10	15	20	25	32	40	
Cv flow factor	10	6	16	29	50	98	125	
Working pressure range MPa	0 to 1.0							
Operation time sec	AC	10/8 (50/60 Hz)			13/11 (50/60 Hz)			
	DC	8			10.5			
Cycle rate	AC	2 cycles/min. or less			1 cycle/min. or less			
	Note 4 DC	1 cycle/min. or less			1 cycle/2 min. or less			
Weight kg	Bronze body	1.2	1.2	1.4	1.5	2.5	3.0	3.7
	Stainless steel body	1.2	1.2	1.4	1.5	2.6	3.1	3.8

## MXB1F (full bore) individual specifications

Item	MXB1F-15	MXB1F-20	MXB1F-25	MXB1F-32	MXB1F-40
Port size	Rc1/2	Rc3/4	Rc1	Rc1 1/4	Rc1 1/2
Orifice mm	15	20	25	32	40
Cv flow factor	23	51	66	114	176
Working pressure range MPa	0 to 1.0				
Operation time sec	AC	10/8 (50/60 Hz)		13/11 (50/60 Hz)	
	DC	8		10.5	
Cycle rate	AC	2 cycles/min. or less		1 cycle/min. or less	
	Note 4 DC	1 cycle/min. or less		1 cycle/2 min. or less	
Weight kg	1.4	1.5	2.5	3.0	3.7

Note 1: Allowable voltage range must be within ±10% of the rated voltage.

Note 2: Each ampere is the value at the rated voltage.

Note 3: MXB1-10 is full bore.

Note 4: Cycle rate must be within the specifications.

Note 5: Consult with CKD about other than above specifications.



## How to order

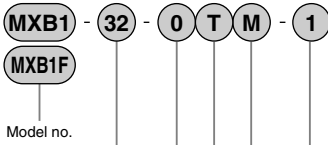

**A** Port size

**B** Body/seal material

**C** Other options

\*1

\*2

**D** Manual  
\*3 override

**E** Voltage

		Model no.			
Symbol	Descriptions	MXB1 (standard bore)	MXB1F (full bore)		
<b>A Port size</b>					
<b>10</b>	Rc3/8 *4	●			
<b>15</b>	Rc1/2	●	●		
<b>20</b>	Rc3/4	●	●		
<b>25</b>	Rc1	●	●		
<b>32</b>	Rc1 1/4	●	●		
<b>40</b>	Rc1 1/2	●	●		
<b>50</b>	Rc2	●	●		
<b>B Body/seal material</b>					
<b>0</b>	Body - bronze, seat - PTFE	●	●		
<b>H</b>	Body - bronze, seat - reinforced PTFE	●	●		
<b>E</b>	Body - stainless steel, seat - PTFE	●			
<b>W</b>	Body - stainless steel, seat - reinforced PTFE	●			
<b>C Other options</b>					
Descriptions	Applications	Remarks			
<b>Blank</b>	5-conductor cable 0.5 mm <sup>2</sup> (output lead wire)	—	—	●	●
<b>T</b>	3-conductor cable 0.75 mm <sup>2</sup> (no output)	Output lead wire not required	3-conductor catbrite cord used	●	●
<b>B</b>	Round terminal box (5 terminals)	Optional lead wire length required	—	●	●
<b>L</b>	Round terminal box + light (ON when open, 3 terminals)	Fully open confirmation by light	Lights at fully open	●	●
<b>R</b>	Round terminal box + light (ON when closed, 3 terminals)	Fully closed confirmation by light	Lights at fully closed	●	●
<b>D Manual override</b>					
<b>Blank</b>	Blank			●	●
<b>M</b>	Manual override			●	●
<b>E Voltage</b>					
<b>1</b>	100 VAC (50/60 Hz)			●	●
<b>2</b>	200 VAC (50/60 Hz)			●	●
<b>3</b>	24 VDC			●	●
<b>4</b>	12 VDC			●	●

\*1: When selecting both no output (● T) and a round terminal box (● B) as options, designate ● as TB.

A 3-terminal round terminal box will be provided.

\*2: Combinations of LR, TL, TR, BL and BR aren't available for ●.

\*3: When the manual override (● M) is selected, available port sizes are 32, 40 and 50 for MXB1.  
For MXB1F, available port sizes are 25, 32 and 40.

For the other port sizes, the manual override is equipped as standard.

\*4: When port size is 10, the valve is full bore but the model is MXB1.

## <Example of model number>

### MXB1F-32-OTM-1

Model no.: MXB1F (full bore)

- A** Port size : Rc1 1/4
- B** Body/seal material : Body - bronze, seat - PTFE
- C** Other options : 3-conductor cable (no output)
- D** Manual override : Selected
- E** Voltage : 100 VAC (50/60 Hz)

HNB/G

USB/G

FAB/G

FGB/G

FVB

FWB/G

FHB

FLB

AB

AG

AP/  
AD

APK/  
ADK

For  
dry air

Explosion  
proof

HVB/  
HVL

SAB/  
SVB

NP/NAP/  
NVP

CHB/G

MXB/G

Other G.P.  
systems

PD/FAD/  
PJ

CVB/  
CVSE

CPE/  
CPD

Medical  
analysis

Custom  
order

Motor driven 2 port ball valve

# MXB1/MXB1F Series

## Internal structure and parts list

● MXB1/MXB1F

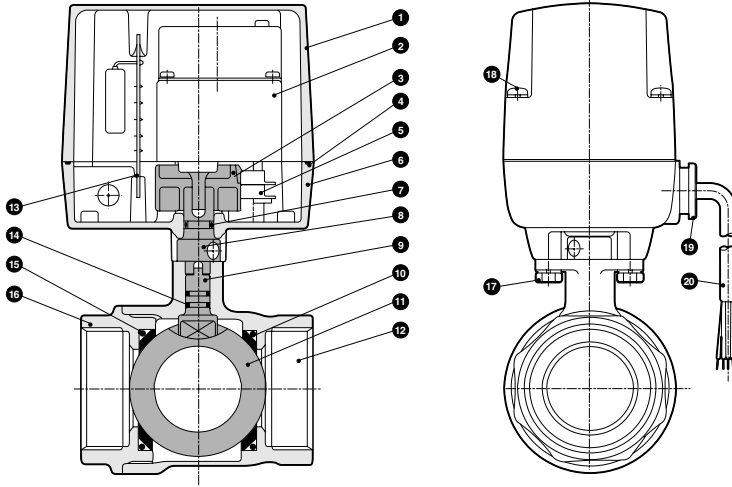

No.	Parts name	Material	No.	Parts name	Material
1	Bonnet	ADC12 Aluminum die casting	11	Valve ball	C3771 (SUS304) Brass *2 (stainless steel)
2	Geared motor	-	12	Body	CAC408, CAC407 (SCS13) Bronze casting (stainless steel casting)
3	Cam	PA Polyamide resin	13	P plate assembly	PF Phenol resin
4	Gasket	NBR Nitrile rubber	14	O ring *1	FKM, NBR Fluoro rubber, nitrile rubber
5	Micro switch	-	15	O ring	FKM Fluoro rubber
6	Adaptor	ZDC2 Zinc alloy die-casting	16	Cap	CAC408, CAC407 (SCS13) Bronze casting (stainless steel casting)
7	O ring	NBR Nitrile rubber	17	Hexagon head bolt	SWRM Carbon steel wire for cold forging
8	Intermediate bush	SUS303 Stainless steel	18	Cross-headed pan head machine screw	SWRM Carbon steel wire for cold forging
9	Shaft	SUS303 (SUS304) Stainless steel (stainless steel)	19	Bushing	PF Phenol resin
10	Ball seat	PTFE Tetrafluoroethylene resin	20	Cable tie cord	0.5 mm <sup>2</sup> , 5-conductor -

Materials shown in ( ) are for stainless steel body.

\*1: The upper O ring is NBR, and the lower is FKM. For stainless steel body, FKM is used for both upper and lower O rings.

\*2: The valve ball is made of hard chrome plated brass.

## Dimensions (Page 612)

- MXB1-10/15/20/25-\*
- MXB1F-15/20-\*

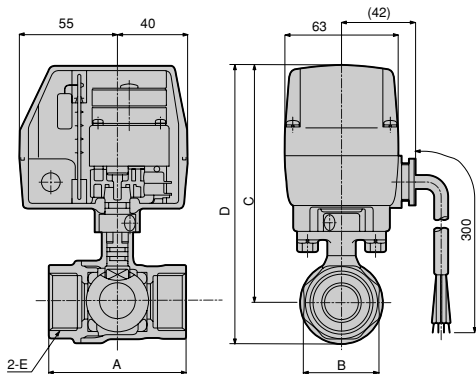

Cabtire cord length 300 mm

Model no.	A	B	C	D	E
<b>MXB1-10-*</b>	50 (56)	24 (28)	124.5	139.5 (140.5)	Rc3/8
<b>MXB1-15-*</b>	56	28	124.5	139.5 (140.5)	Rc1/2
<b>MXB1-20-*</b>	65	34	130.5	150 (151)	Rc3/4
<b>MXB1-25-*</b>	76	41	133.5	156.5 (157.5)	Rc1
<b>MXB1F-15-*</b>	65	28	130.5	150	Rc1/2
<b>MXB1F-20-*</b>	71	34	133.5	156.5	Rc3/4

Note 1: Values shown in ( ) are for stainless steel body.

- MXB1-32/40/50-\*
- MXB1F-25/32/40-\*

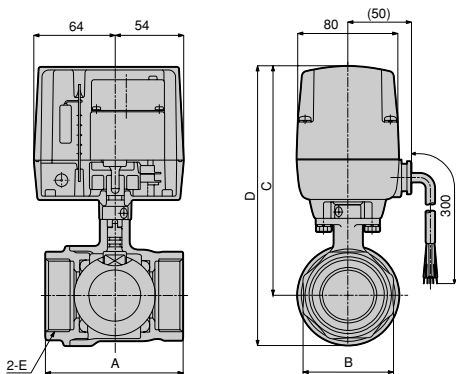

Cabtire cord length 300 mm

Model no.	A	B	C	D	E
<b>MXB1-32-*</b>	84	50	166	193.5 (195.5)	Rc1 1/4
<b>MXB1-40-*</b>	94	57	172	205.5 (207.5)	Rc1 1/2
<b>MXB1-50-*</b>	108	70	181	220.5 (221.5)	Rc2
<b>MXB1F-25-*</b>	84	41	166	193.5	Rc1
<b>MXB1F-32-*</b>	95	50	172	205.5	Rc1 1/4
<b>MXB1F-40-*</b>	107	57	181	220.5	Rc1 1/2

Note 1: For valves with manual override "M", the MSB1 Series yoke is inserted between the valve and actuator, making dimensions C and D 22 mm longer.

Note 2: Values shown in ( ) are for stainless steel body.

## Optional dimensions (Page 612)

- Round terminal box  
MXB1/MXB1F-[Port size]-\*

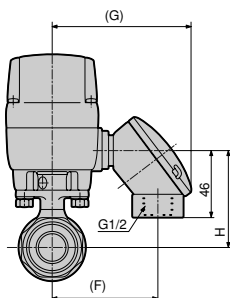

- Round terminal box + light  
MXB1/MXB1F-[Port size]-\*

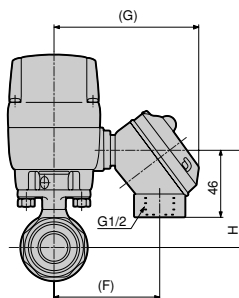

Port size		F	G	H
MXB1	MXB1F			
<b>10</b>	-	74	96	58.5
<b>15</b>	-	74	96	58.5
<b>20</b>	15	74	96	64.5
<b>25</b>	20	74	96	67.5
<b>32</b>	25	82	104	77.5 (Note 1)
<b>40</b>	32	82	104	83.5 (Note 1)
<b>50</b>	40	82	104	92.5 (Note 1)

Port size		F	G	H
MXB1	MXB1F			
<b>10</b>	-	74	101	58.5
<b>15</b>	-	74	101	58.5
<b>20</b>	15	74	101	64.5
<b>25</b>	20	74	101	67.5
<b>32</b>	25	82	109	77.5 (Note 1)
<b>40</b>	32	82	109	83.5 (Note 1)
<b>50</b>	40	82	109	92.5 (Note 1)

Note 1: For valves with manual override "M", the MSB1 Series yoke is inserted between the valve and actuator, making dimensions 22 mm longer.

HNB/G  
USB/G  
FAB/G  
FGB/G  
FVB  
FWB/G  
FHB  
FLB  
AB  
AG  
AP/  
AD  
APK/  
ADK  
For  
dry air  
Explosion  
proof  
HVB/  
HVL  
SAB/  
SVB  
NP/NAP/  
NVP  
CHB/G  
MXB/G  
Other G.P.  
systems  
PD/FAD/  
PJ  
CVE/  
CVSE  
CPE/  
CPD  
Medical  
analysis  
Custom  
order

Motor driven 2 port ball valve

# MXB/MXG Series

## Electronic Catalog file list

### Motor driven 2, 3 port ball valve MXB/MXG

#### Standard type MXB/MXG

Electronic Catalog file list is applied to "CAD DATA 2006".

Model no.	DXF		MICRO CADAM
	Folder name	Filename	Filename (GROUP: CAD, USER: STDLIB)
<b>● 2 port valve MXB: Page 561</b>			
MXB1-10	MXB_MXG	mxb1_10	CKD-MXB1-10
MXB1-15		mxb1_15	CKD-MXB1-15
MXB1-20		mxb1_20	CKD-MXB1-20
MXB1-25		mxb1_25	CKD-MXB1-25
MXB1-32		mxb1_32	CKD-MXB1-32
MXB1-40		mxb1_40	CKD-MXB1-40
MXB1-50		mxb1_50	CKD-MXB1-50
MXB1-10-E/W/N		mxb1_10_e_w_n	CKD-MXB1-10-E/W/N
MXB1-15-E/W/N		mxb1_15_e_w_n	CKD-MXB1-15-E/W/N
MXB1-20-E/W/N		mxb1_20_e_w_n	CKD-MXB1-20-E/W/N
MXB1-25-E/W/N		mxb1_25_e_w_n	CKD-MXB1-25-E/W/N
MXB1-32-E/W/N		mxb1_32_e_w_n	CKD-MXB1-32-E/W/N
MXB1-40-E/W/N		mxb1_40_e_w_n	CKD-MXB1-40-E/W/N
MXB1-50-E/W/N		mxb1_50_e_w_n	CKD-MXB1-50-E/W/N
MXB1F-15		mxb1f_15	CKD-MXB1F-15
MXB1F-20		mxb1f_20	CKD-MXB1F-20
MXB1F-25		mxb1f_25	CKD-MXB1F-25
MXB1F-32		mxb1f_32	CKD-MXB1F-32
MXB1F-40		mxb1f_40	CKD-MXB1F-40
Round terminal box, round terminal box + light		mxb_mxbg_b_l_r	CKD-MXB/MXG-B/L/R
<b>● 3 port valve MXG: Page 565</b>			
MXG1-15	MXB_MXG	mxg1_15	CKD-MXG1-15
MXG1-20		mxg1_20	CKD-MXG1-20
MXG1-25		mxg1_25	CKD-MXG1-25
MXG1-32		mxg1_32	CKD-MXG1-32
MXG1-40		mxg1_40	CKD-MXG1-40
MXG1-50		mxg1_50	CKD-MXG1-50
MXG1-15-E/W/N		mxg1_15_e_w_n	CKD-MXG1-15-E/W/N
MXG1-20-E/W/N		mxg1_20_e_w_n	CKD-MXG1-20-E/W/N
MXG1-25-E/W/N		mxg1_25_e_w_n	CKD-MXG1-25-E/W/N
MXG1-32-E/W/N		mxg1_32_e_w_n	CKD-MXG1-32-E/W/N
MXG1-40-E/W/N		mxg1_40_e_w_n	CKD-MXG1-40-E/W/N
MXG1-50-E/W/N		mxg1_50_e_w_n	CKD-MXG1-50-E/W/N
Round terminal box, round terminal box + light		mxb_mxbg_b_l_r	CKD-MXB/MXG-B/L/R

#### High corrosion resistant MXB1-C (page 569)

Model no.	DXF		MICRO CADAM
	Folder name	Filename	Filename (GROUP: CAD, USER: STDLIB)
MXB1-15-C	MXB1_C	mxb1_15_c	CKD-MXB1-15-C
MXB1-20-C		mxb1_20_c	CKD-MXB1-20-C
MXB1-25-C		mxb1_25_c	CKD-MXB1-25-C
MXB1-32-C		mxb1_32_c	CKD-MXB1-32-C
MXB1-40-C		mxb1_40_c	CKD-MXB1-40-C
MXB1-50-C		mxb1_50_c	CKD-MXB1-50-C

### MSB for steam (page 593)

Electronic Catalog file list is applied to "CAD DATA 2006".

Model no.	DXF		MICRO CADAM
	Folder name	Filename	Filename (GROUP: CAD, USER: STDLIB)
MSB1-10	MSB	msb1_10	CKD-MSB1-10
MSB1-15		msb1_15	CKD-MSB1-15
MSB1-20		msb1_20	CKD-MSB1-20
MSB1-25		msb1_25	CKD-MSB1-25
MSB1-32		msb1_32	CKD-MSB1-32
MSB1-40		msb1_40	CKD-MSB1-40
MSB1-50		msb1_50	CKD-MSB1-50
MSB1F-15		msb1f_15	CKD-MSB1F-15
MSB1F-20		msb1f_20	CKD-MSB1F-20
MSB1F-25		msb1f_25	CKD-MSB1F-25
MSB1F-32		msb1f_32	CKD-MSB1F-32
MSB1F-40		msb1f_40	CKD-MSB1F-40

### Proportional control MXBC/MXGC (page 601)

Model no.	DXF		MICRO CADAM
	Folder name	Filename	Filename (GROUP: CAD, USER: STDLIB)
MXBC-10	MXBCMXGC	mxbc_10	CKD-MXBC-10
MXBC-15		mxbc_15	CKD-MXBC-15
MXBC-20		mxbc_20	CKD-MXBC-20
MXBC-25		mxbc_25	CKD-MXBC-25
MXGC-15		mxgc_15	CKD-MXGC-15
MXGC-20		mxgc_20	CKD-MXGC-20
MXGC-25		mxgc_25	CKD-MXGC-25

### Miniature type MHB4/MHG4 (pages 606 to 607)

Model no.	DXF		MICRO CADAM
	Folder name	Filename	Filename (GROUP: CAD, USER: STDLIB)
MHB4-10	MHB4MHG4	mhb4_10	CKD-MHB4-10
MHB4-15		mhb4_15	CKD-MHB4-15
MHB4-20		mhb4_20	CKD-MHB4-20
MHG4-10		mhg4_10	CKD-MHG4-10
MHG4-15		mhg4_15	CKD-MHG4-15
MHG4-20		mhg4_20	CKD-MHG4-20

### Motor driven ball valve temperature control system MHBP (page 610)

Model no.	DXF		MICRO CADAM
	Folder name	Filename	Filename (GROUP: CAD, USER: STDLIB)
MHBP-15	MHBP	mhb_15	CKD-MHBP-15
MHBP-20		mhb_20	CKD-MHBP-20
MHBP-25		mhb_25	CKD-MHBP-25

HNB/G

USB/G

FAB/G

FGB/G

FVB

FWB/G

FHB

FLB

AB

AG

AP/

AD

APK/

ADK

For

dry air

Explosion

proof

HVB/

HVL

SAB/

SVB

NP/NAP/

NVP

CHB/G

MXB/G

Other G.P.

systems

PD/FAD/

PJ

CVE/

CVSE

CPE/

CPD

Medical

analysis

Custom

order

Direct acting 2, 3 port solenoid valve